

Specifications and equipment are subject to change without any notice or obligation on the part of the manufacturer. March 2023 ©2023 NIKON CORPORATION

WARNING TO ENSURE CORRECT USAGE, READ THE CORRESPONDING MANUALS CAREFULLY BEFORE USING YOUR EQUIPMENT.

Monitor images are simulated.
 Company names and product names appearing in this brochure are their registered trademarks or trademarks.
 N.B. Export of the products* in this brochure is controlled under the Japanese Foreign Exchange and Foreign Trade Law.
 Appropriate export procedure shall be required in case of export from Japan.
 *Products: Hardware and its technical information (including software)



Nikon Healthcare
 Business Unit website



NIKON CORPORATION
 Headoffice
 Shinagawa Intercity Tower C, 2-15-3, Konan, Minato-ku, Tokyo 108-6290, Japan
 phone: +81-3-6433-3705 fax: +81-3-6433-3785
<https://www.healthcare.nikon.com/en/>

Manufacturer
 471, Nagaodai-cho, Sakae-ku, Yokohama, Kanagawa 244-8533 Japan

ISO 14001 Certified
 for NIKON CORPORATION

Nikon Instruments Inc.
 1300 Walt Whitman Road, Melville, N.Y. 11747-3064, U.S.A.
 phone: +1-631-547-8500; +1-800-52-NIKON (within the U.S.A. only)
 fax: +1-631-547-0299A
<https://www.microscope.healthcare.nikon.com/>

Nikon Europe B.V.
 Stroombaan 14, 1181 VX Amstelveen, The Netherlands
 phone: +31-20-7099-000
https://www.microscope.healthcare.nikon.com/en_EU/

Nikon Precision (Shanghai) Co., Ltd.
 CHINA phone: +86-21-6841-2050 fax: +86-21-6841-2060
 (Beijing branch) phone: +86-10-5831-2028 fax: +86-10-5831-2026
 (Guangzhou branch) phone: +86-2-3882-0551 fax: +86-2-3882-0580
https://www.microscope.healthcare.nikon.com/zh_CN/

Nikon Canada Inc.
 CANADA phone: +1-905-625-9910 fax: +1-905-602-9953
Nikon France, Succursale de Nikon Europe B.V.
 FRANCE phone: +33-1-4516-4516

Nikon Deutschland, Zweigniederlassung der Nikon Europe B.V.

GERMANY phone: +49-211-9414-888
Nikon Italy, Branch of Nikon Europe B.V.
 ITALY phone: +39-055-300-9601

Nikon Europe B.V., Amstelveen, Zweigniederlassung Schweiz (Egg/ZH)

SWITZERLAND phone: +41-43-277-2867
Nikon UK, Branch of Nikon Europe B.V.
 UNITED KINGDOM phone: +44-208-247-1717

Nikon Österreich, Zweigniederlassung der Nikon Europe B.V.

AUSTRIA phone: +43-1-972-6111
Nikon Singapore Pte. Ltd.
 SINGAPORE phone: +65-6559-3651 fax: +65-6559-3668

Nikon Australia Pty Ltd

AUSTRALIA phone: +61-2-8767-6900
Nikon Instruments Korea Co., Ltd.
 KOREA phone: +82-2-6288-1900 fax: +82-2-555-4415

abacus dx

Distributed by Abacus dx:

1800 222 287 (AU) | 0800 222 170 (NZ)

info@abacusdx.com.au

abacusdx.com



DIGITAL IMAGING MICROSCOPE

ECLIPSE Ui

A REAL SOLUTION FOR DIGITAL PATHOLOGY

Live on-screen diagnosis.

Nikon's new ECLIPSE Ui Digital Upright Microscope provides accurate microscopy-based pathology imaging. View and share high quality images in real time with easy to use software for a simpler workflow.

VIEW

Display high quality images while remaining simple to operate

Sample images are monitored in real time. The quality is backed by Nikon's renowned imaging technology - clear color reproducibility without negative influence from ambient lights. Operator eye fatigue is greatly reduced as the need to look through conventional eyepieces is eliminated.

FAST

Immediate response for quicker workflow.

The system is operational in 2.5 seconds after loading a sample. Digital sample images can be observed live, plus magnification changes and XY movements can be quickly adjusted. It is also equipped with macro-imaging function and other sample-oriented applications.

USABILITY

User-friendly to promote operational efficiency.

The GUI (graphical user interface) is intended for easy identification and for efficient observation tasks. The functions needed to observe the sample images are arranged in an operator-friendly and efficient manner.

DAILY SUPPORT

Functions to support multiple use cases and applications.

The system is provided with three modes: routine specimen observation tasks, research* and education*, and data sharing. Users can select their preferred imaging quality and speed. Automatic bar code linkage from slide to image ensures sample control.

* Not for use in diagnostic procedures.



DIGITAL IMAGING MICROSCOPE
ECLIPSE Ui



VIEW

Display high quality images while remaining simple to operate.

1 New category medical equipment for turning pathological samples digital.

The internal PC provides all the necessary functions and applications.

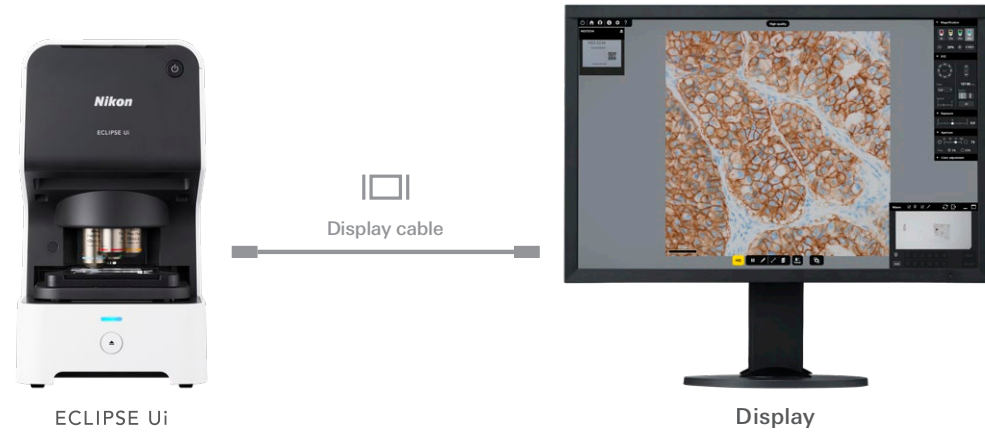

2 Images on the monitor screen for easy observation.

It is no longer necessary to sit for hours looking through microscope eyepieces. The images are shared onscreen, suitable for two or more people to discuss the samples.



3 Time-proven optical-mechanical performance of Nikon microscopes.

The CFI Plan Fluor series objectives are backed by Nikon's superior optical technology. Their transmittance and numerical aperture (resolving power) are acclaimed for their high standard.



4 Nikon's renowned imaging expertise.

Images are easy to observe while afterimages are minimized. Nikon's imaging techniques ensure color reproducibility. Scrolling is smooth and fast and the brightness and color tones are adjustable.

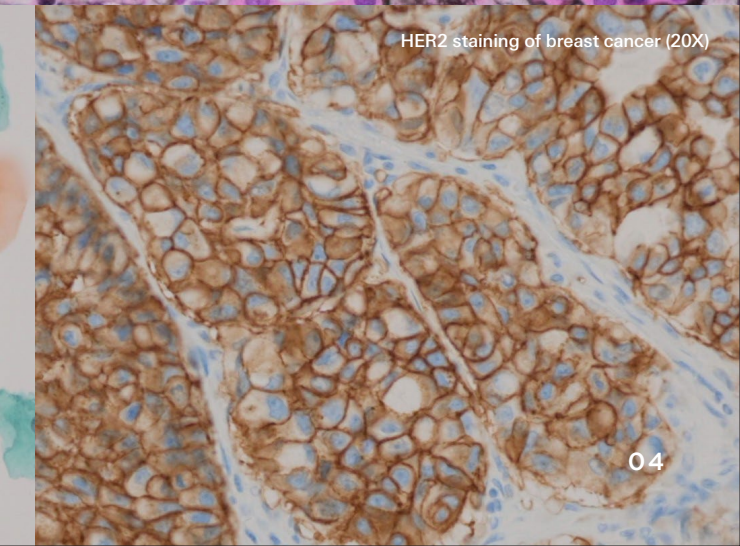
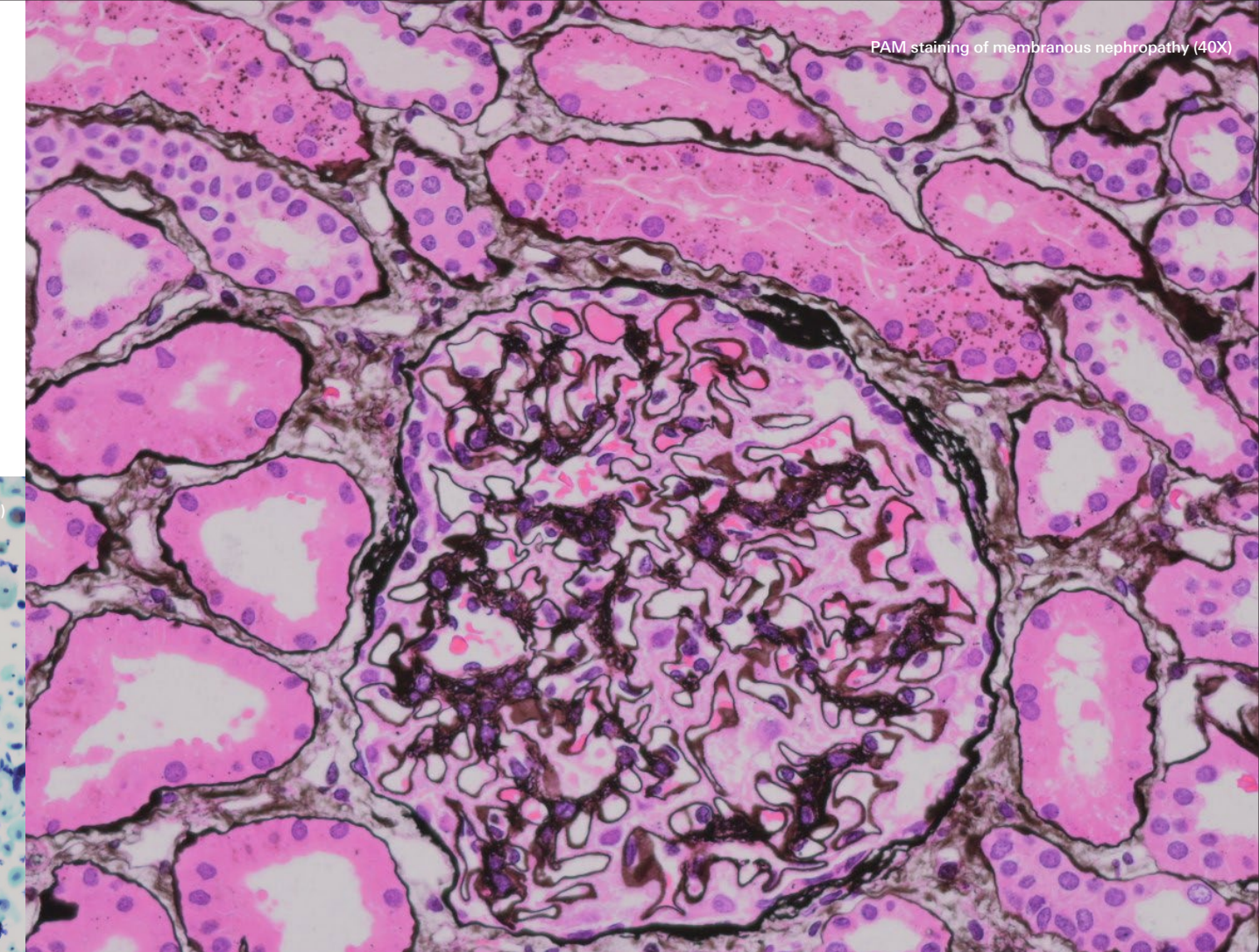
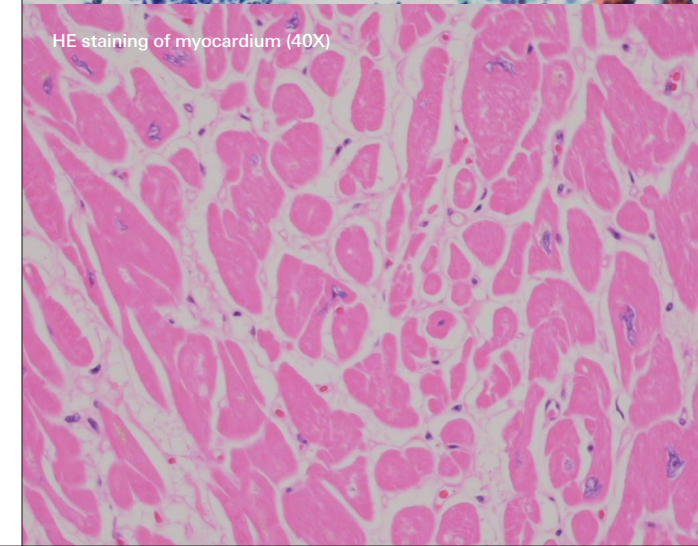
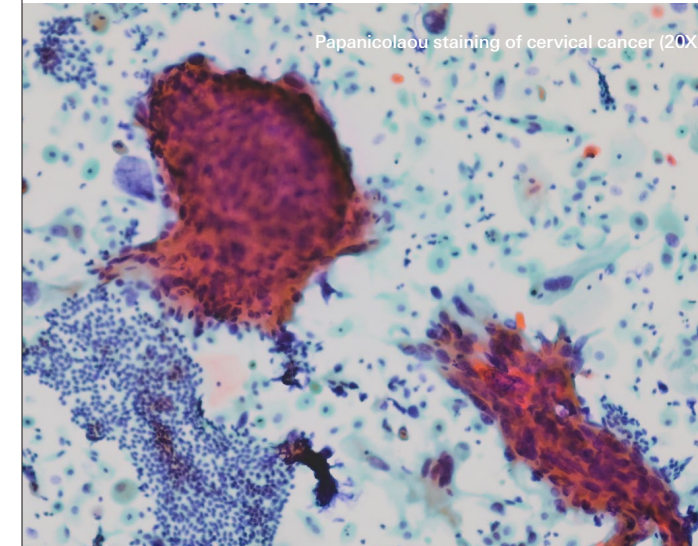

FAST

Immediate response for quicker workflow.

1 Operator-friendly

A prepared slide with sample can be placed with one hand. Onscreen control for magnification changes, X-Y movement and focusing makes for efficient performance.

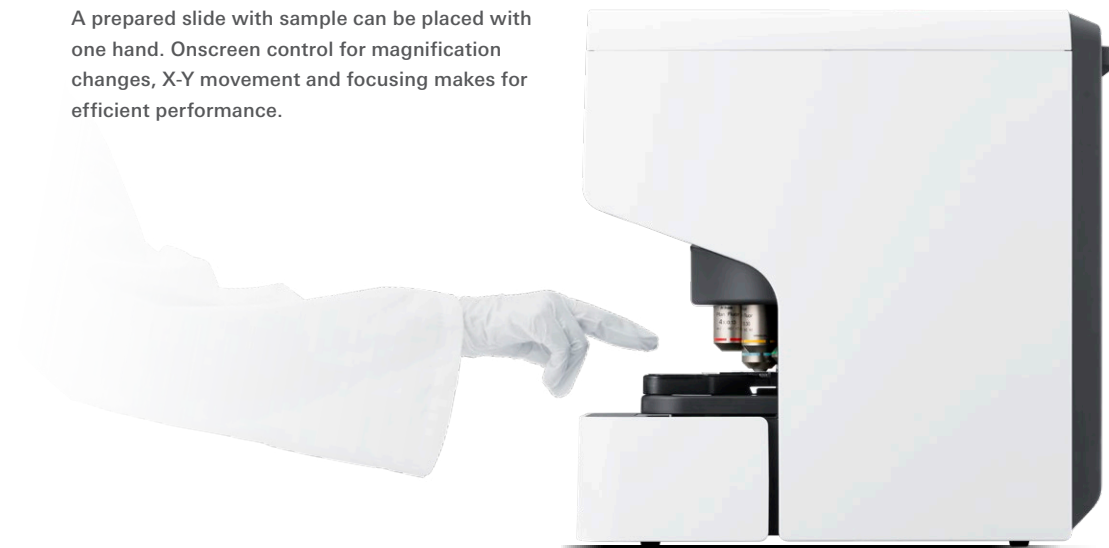

2 A sample can be observed in 2.5 seconds after being loaded.

Samples are loaded at the touch of a button and displayed on the monitor in 2.5 seconds.

3 The macro-imaging function is available for overviewing samples.

A sample is captured for a macro-image together with the target location. They are displayed along with the stage. Using the overview, the region in question can be observed. That site can be marked on the spot and the preset monitoring location can be recalled with just one click. The macro-image displayed may be saved as required.

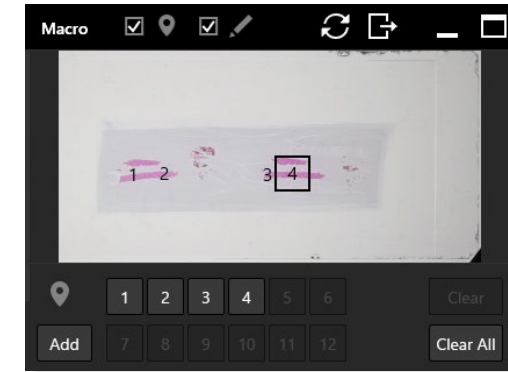

4 Equipped with various support functions.

The system is designed to meet various use cases, such as Thick sample observation and recording, and successive observation.

- **Z-stack function***
The Z-stack function enables to observing and recording images that are thick, undulating or disperse in the Z axis.
*Not for use in diagnostic procedures.
- **Stepwise transfer**
For convenient successive observation, the stage can be shifted at a constant rate. This step-by-step function has been developed with less afterimage in mind. Six speed settings can be preset for suitable scrolling.



Starting the system

- Press the Power button.
- Log in.
- Select an operating mode.

Preparations

- Place a prepared slide with sample on the holder.
- Press the Sample Load/Unload button.

Checking the entire image

- Check the sample ID information.
- Look at the macro-image to check the full view.
- Send the macro-image to the pathological system.
- Specify the area to observe on the macro-image.

Observing live and diagnosing

- Focus adjustment.
- Exposure adjustment.
- Refer to pp. 7-8 for details.

Observation complete

- Press the Sample Load/Unload button.
- Take out the prepared slide.

Shutting down the system

- Press the Power button.

USABILITY

To promote operational efficiency.

The system is equipped with the GUI for easy identification and for efficient observation tasks.

The functions needed to observe sample images are arranged in a user-friendly way. Simultaneously captured micro- and macro-images are displayed live.

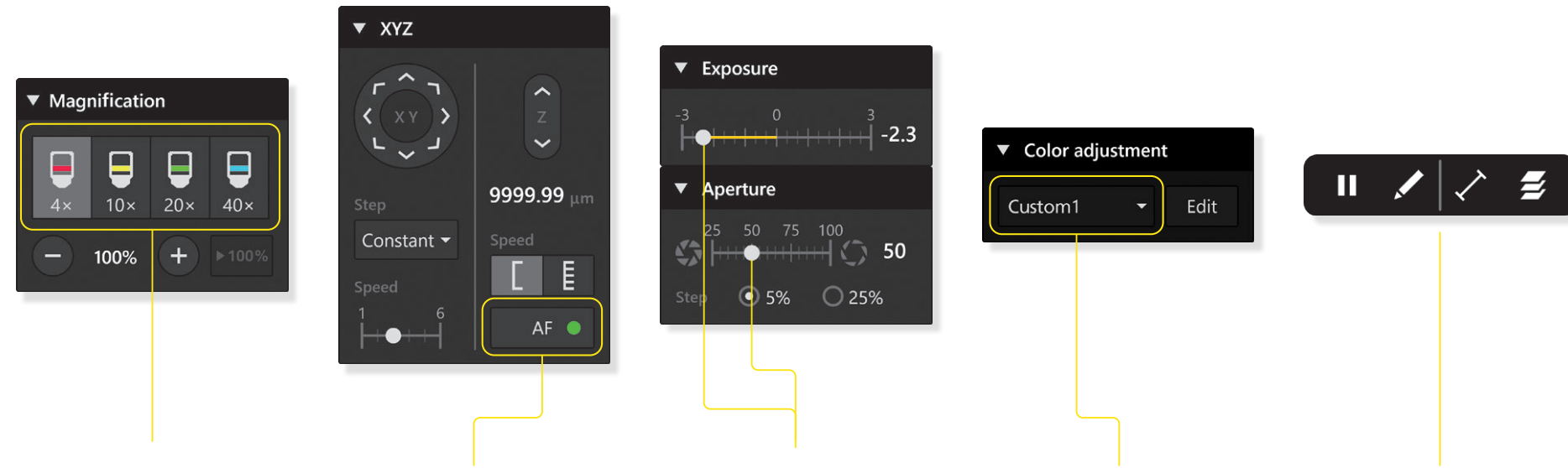

Magnifications changeable with the touch of a button

Digital zoom-in/out available.

Easy Focus function

Equipped with the auto-focus function. Focus adjustment also possible with the onscreen button AF or the mouse wheel.

Brightness adjustment with the slide bar

Exposure and aperture adjustable by dragging the slide bars onscreen to the right or left.

Color adjustment

Shades and contrasts changeable as required.

Annotations added*

Areas of interest can be marked as well as point-to-point measurements made in the displayed image.

*Not for use in diagnostic procedures.



DAILY SUPPORT

Functions for use

1 Mode selection to meet use cases.

Routine

In this mode, cytoscreening is supported. Sample images displayed live on the monitor screen are used for routine pathological image observation and successive observation. Images can also be transferred to pathological systems.

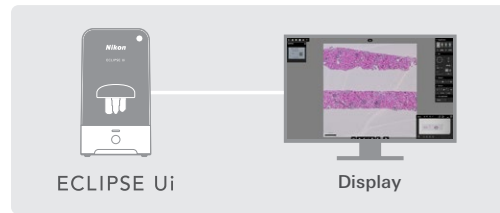

Research^{*1}

Data (sample images, observation spots, etc.) to share or discuss are saved in an external storage^{*2}. This data can be utilized for relevant studies and education.

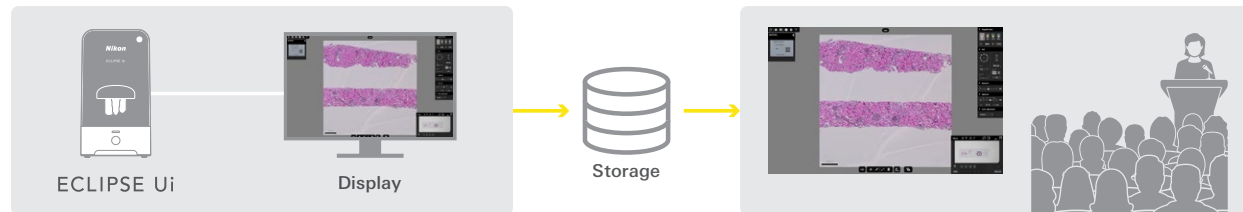

Remote^{*1}

This mode allows remote user (users on contract) in remote locations to operate the system in real time. These users can also observe images^{*3}.

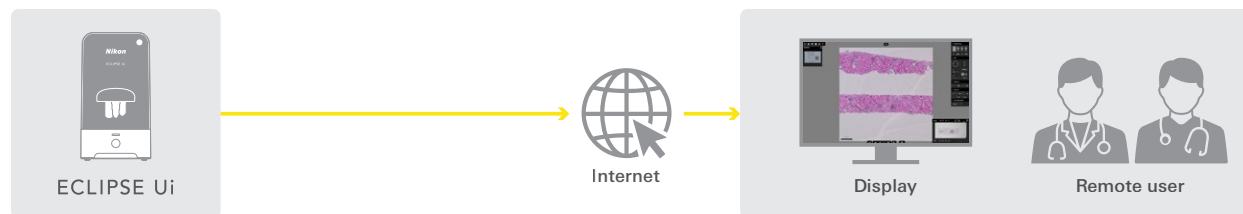

*1: Not for use in diagnostic procedures.

*2: Separately sold.

*3: Separate contract must be concluded for using the Remote mode. For communication environment, contact us.

cases, applications of images and sample control.

2 Compact size and a well thought-out design

The space-saving body measures 422 mm in height, 233 mm in width and 427 mm in depth. Ambient light does not affect images. The microscope is readily set up.



3 Different resolutions and frame rates to meet applications.

There are two types of image output: LIVE for immediate observation and evaluation, and High-Quality for saving and storage.

LIVE
(Observation mode)
1080 x 1080, above 30 fps

High-Quality
(Capture mode)
3712 x 3712, above 1 fps

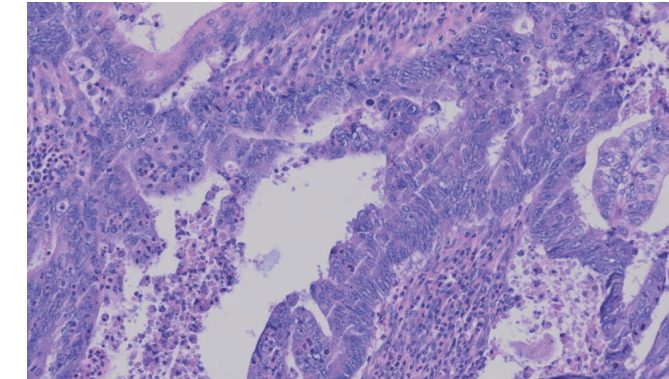

3712 x 3712, above 1 fps

4 Bar code reading for efficient sample control.

Bar code and 2D code (QR code) are easily read. Sample numbers can also be displayed and saved. No more mixed-up samples.

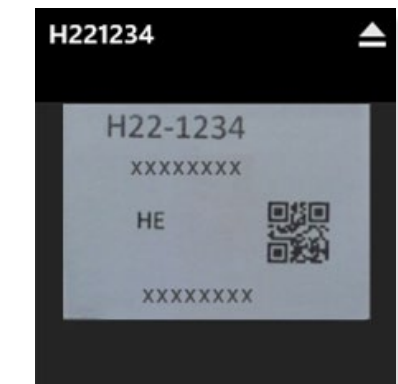

NETWORK ACCESS

1 Data sharing through remote access*

Users (on contract) in remote locations may access and operate the system. Information and data are more widely shared, and medical treatment discussion gets easier. Immediate and accurate observation is now possible.

* For this function, separate contract must be concluded for using the Remote mode. * For communication environment, contact us. * Not for use in diagnostic procedures.

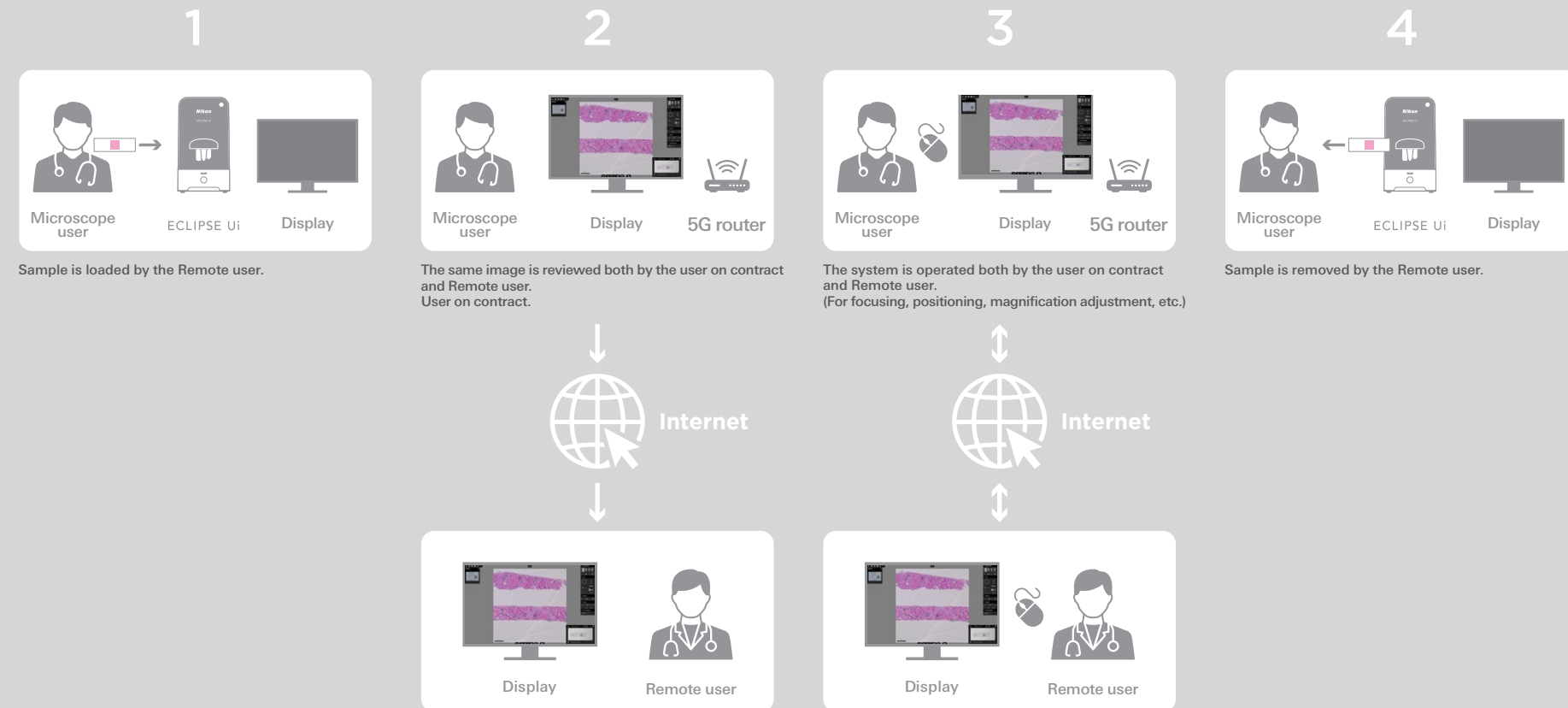

Digital medical system compatible with network



SPECIFICATIONS

System

diagram and specifications

DIAGRAM

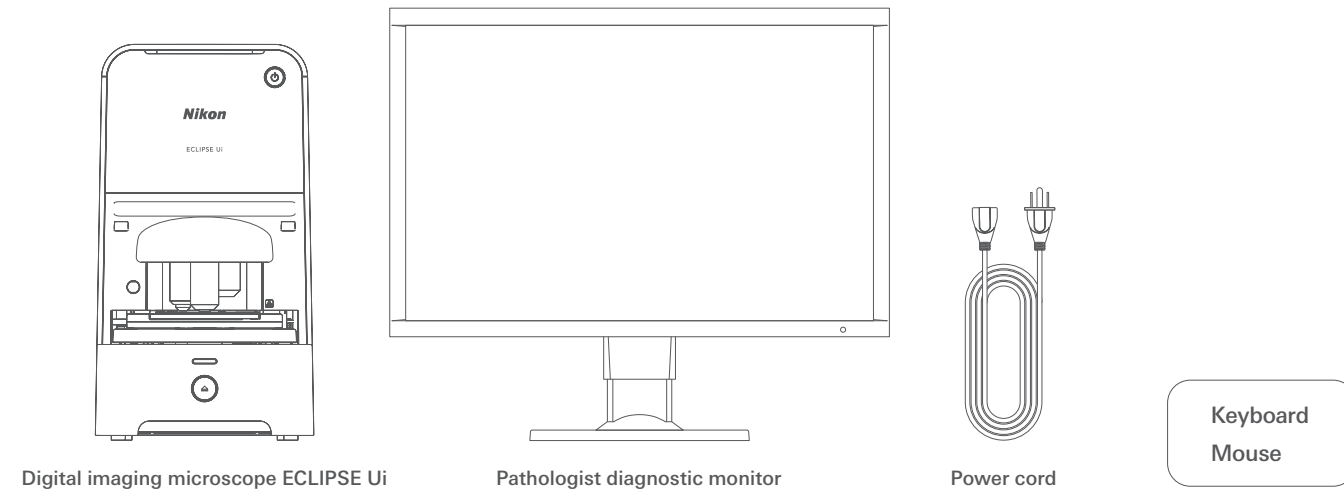

DIMENSIONS

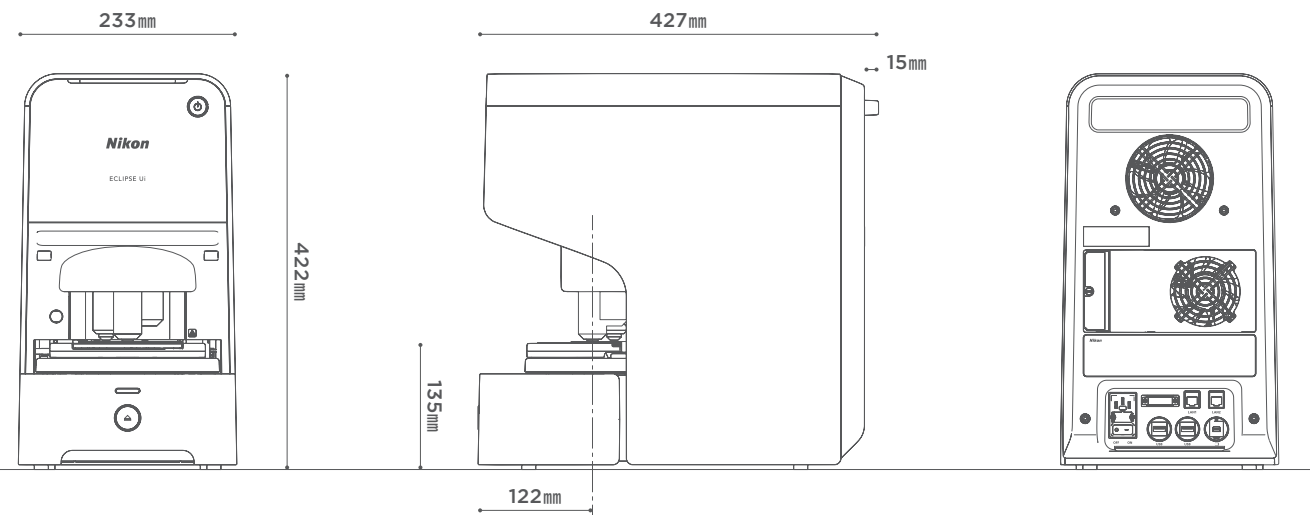

SPEC

Model	ECLIPSE Ui US / EU	
Microscopy technique	Diascopic bright-field observation (Koeher illumination)	
Observable specimens	<p>One prepared slide</p> <p>Thickness: 0.9 to 1.7 mm (comprising the thickness of the slide glass, specimen, mounting medium, and cover glass)</p> <ul style="list-style-type: none"> Microscope slide (ISO8037 compliant) Thickness: 0.9 to 1.2 mm Size: 76 mm x 26 mm Cover glass (ISO8255-compliant) Thickness: 0.17 mm Size: 18 to 60 mm x 18 to 25 mm <p>* Do not use any other types of microscope slide and cover glass.</p>	
Observable range	Macro-image:	Prepared slide allover (75 mm x 26 mm)
	Micro-image:	Cover glass allover (60 mm x 25 mm or larger)
Optical system	Light source:	High-intensity white LED (for macro- and micro-images)
	Number of fields of view:	22
	Objectives:	CFI Plan Fluor 4X, CFI Plan Fluor 10X, CFI Plan Fluor 20X, CFI Plan Fluor 40X
Motorized Function	Nosepiece movement, stage movement (incl. sample loading), objectives focus, aperture stop, sample holder clips open/close, macro/micro observation switching	
Focus drive	Objectives vertical movement system	
	Stroke:	10.3 mm
	Focusing speed (maximum):	0.7 mm/s or more
Stage	Stroke:	X; 78 mm, Y; 28 mm
	Moving velocity (maximum):	X: 85 mm/s, Y: 78 mm/s
Aperture diaphragm unit	Aperture diameter:	Ø1.2 mm to Ø28.1 mm
		25% to 100% Supported specimen
Barcode	2D barcodes:	QR code, Data Matrix code
	1D barcodes:	CODE-128
Micro-imaging	X-Y staging:	Half, Full, and Repeat (For Repeat, steps 1 to 6 can be selected for each objective.)
	Display modes:	Live; 1080 x 1080 30 fps High-Quality; 3712 x 3712, 1 fps
Focus	Contrast AF, manual focus	
Exposure compensation	-2 to +2 EV	
Color adjustment	Contrast, Brightness, Saturation, Hue	
	Point registration*: Registrable up to 12 points	
Marking mode*	Maximum number of spots:	499
	Spot size:	8px, 16px and 32px selectable

Measurement mode*	Line segment and length scale display between two points	
Image capture*	Static macro image capture:	1330 x 460
	Static micro image capture:	Live; 1080 x 1080 High-Quality; 3712 x 3712
	Z-stack image capture:	Number of images: 1 to 21 Photographing interval: 0.5 to 5 µm Setting interval; 0.5 µm
	Images:	Macro (Overall image of observed sample), micro (Microscopic appearance)
Image storage format*	JPEG	
Video capture format*	File format:	MP4
	Image capturing time:	10 minutes (Maximum)
	Compression method:	MPEG-4 Video
	Frame rate:	10 fps
	Resolution:	1080 x 1080
Remote operation*	Video relay:	AWS, WebRTC
External interface	LAN:	GbE 1000 Mbps (two ports)
	USB:	USB2.0 cable, Type A 480 Mbps (two ports)
		Mini Display port:
	Operating system	Windows 10 IoT Enterprise LTSC 2019
Main body ratings	Input ratings:	AC100-240 V±10%, 50/60 Hz
	Maximum power consumption:	170 W
Power cord	<ul style="list-style-type: none"> For use in a 100 - 120 VAC region outside Japan: UL-listed detachable cord set, 3-conductor grounding (3-conductor grounding, Type SVT, No. 18 AWG, maximum length 3 m, Plug Type NEMA5-15P, rated at 125 VAC minimum) For use in a 220-240 VAC region: EU/EN listed detachable cord set, 3-conductor grounding (3-conductor grounding, Type H05VV-F 1 mm², maximum length 3 m, rated at 250 VAC minimum) For use in Japan: PSE approved detachable cord set, 3-conductor grounding (3-conductor grounding, Type VCTF 3 x 0.75 mm², maximum length 3 m, rated at 125 VAC minimum)) 	

* Not for use in diagnostic procedures.